

2023

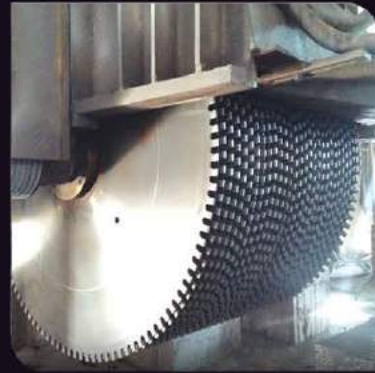

Teller / Wires

	Çoklu Kesim Teli / Multiwire	3
	Plastik Kaplamalı Monotel / Plastic Coated Monowire	4-5
	Plastik Kaplamalı Ocak Teli / Plastic Coated Quarry Wire	6
	Kauçuk Kaplamalı Ocak Teli / Rubber Coated Quarry Wire	7
	Beton Kesim Telleri / Rubber Coated Concrete Wires	8
	Metal Kesim Telleri / Rubber Coated Metal Wires	9
	Power Plus (Sulu Kesim) / Power Plus (Wet Cutting)	10
	Yaylı Tel (Sulu Kesim) / Wire with Spring (Wet Cutting)	11
	Yaylı Tel (Kuru Kesim) / Wire with Spring (Dry Cutting)	12
	Yaylı MSL Tel (Sulu Kesim - Kuru Kesim) / MSL Wire with Spring (Wet Cutting - Dry Cutting)	12
	Yaylı Tel (Sulu Kesim) / Wire with Spring (Wet Cutting)	13
	Aksesuarlar / Accessories	14-16
	Zincirli Kesme Uçları / Chain Saw Segments	17



Katrak Lamaları / Gangsaws Blades

	Katrak Laması / Gangsaw Blades	18-19
---	--------------------------------	-------





Dairesel Testereler / Circular Blades

	Granit Multiblade Testereleri / Granite Multiblades	20
	Granit ST Testereleri / Granite ST Blades	21
	Mermer ST Testereleri / Marble ST Blades	22-23
	Granit Yatay Testereleri / Granite Horizontal Blades	24
	Mermer Yatay - Yarma Testereleri / Marble Horizontal - Splitting Blades	25
	Granit Ebatlama Testereleri / Granite Sizing Blades	26
	Mermer Ebatlama Testereleri / Marble Sizing Blades	27

Dairesel Testereler / Circular Blades

	Seramik-Cam-Porselen Ebatlama Testereleri / Ceramic-Glass-Porcelain Sizing Blades	28
	Turbo Testereler / Turbo Blades	29
	Beton ve Derz Testereleri / Concrete Blades	30-31



Kalibratörler / Calibrations

	Kalibre Tepsileri / Calibrating Plates	32
	Kalibre Tamburları / Calibrating Rollers	33
	Elmas Peçe - Elmas Fickert Abrasiv / Automatic Abrasive - Diamond Fickert Abrasive	34
	Manuel Silim Kalibratörler / Manual Polishing Calibrations	35



Profiller ve Taramalar / Profiles and Shaping Wheels

	Soketli Profiller / Segmented Profiles	36
	Elektroliz-Vakum Profiller / Vacuum Brazed Profiles	37
	Soketli Taramalar / Segmented Canal Saws (Milling Wheels)	38
	Elektroliz-Vakum Taramalar / Electroplated-Vacuum Brazed Canal Saws (Milling Wheels)	39

Karotlar / Drilling Tools

	Beton Karotları / Concrete Drilling Tools	40
	Karotlar / Drilling Tools	41
	Elektroliz-Vakum Karotları / Electroplated-Vacuum Brazed Drilling Tools	42

CNC Uçlar / CNC Tools

	CNC Gravür Frezeleri / CNC Router Bits For Engraving	43
	CNC Parmak Frezeleri / CNC Finger Bits	44

Multiwire Technologies

4,3 mm - 5,3 mm - 6,3 mm - 7,3 mm - 8,3 mm



Çoklu Kesim Teli / Multiwire

Boncuk Ölçüleri (Çap) Bead Size (Diameter)	Boncuk Türü Bead Type	Ürün Cinsi Kind Of Product	Ürün Özellikleri Assembling	Boncuk Sayısı 1 m/Adet Number Of Beads 1 m/Pc	Çevresel Hız m/Saniye Speed Of Rotat. m/Second	Kullanım Alanı Material
4,3	Sinterize / MSL Sinterized / Vacuum Brazed	Plastik Kaplamalı Tel Plastic Coated Wire	Yaysız / Kapalı Çevrim Without Spring / Close Loop	36-37-55	28-35	Mermer / Granit / Kuvarsit Marble / Granite / Quartzite
5,3	Sinterize / MSL Sinterized / Vacuum Brazed	Plastik Kaplamalı Tel Plastic Coated Wire	Yaysız / Kapalı Çevrim Without Spring / Close Loop	36-37-55	28-35	Mermer / Granit / Kuvarsit Marble / Granite / Quartzite
6,3	Sinterize / MSL Sinterized / Vacuum Brazed	Plastik Kaplamalı Tel Plastic Coated Wire	Yaysız / Kapalı Çevrim Without Spring / Close Loop	36-37-55	28-35	Mermer / Granit / Kuvarsit Marble / Granite / Quartzite
7,3	Sinterize / MSL Sinterized / Vacuum Brazed	Plastik Kaplamalı Tel Plastic Coated Wire	Yaysız / Kapalı Çevrim Without Spring / Close Loop	36-37-55	28-35	Mermer / Granit / Kuvarsit Marble / Granite / Quartzite
8,3	Sinterize / MSL Sinterized / Vacuum Brazed	Plastik Kaplamalı Tel Plastic Coated Wire	Yaysız / Kapalı Çevrim Without Spring / Close Loop	36-37-55	28-35	Mermer / Granit / Kuvarsit Marble / Granite / Quartzite

HRK, Multiwire teknolojisinde söz sahibi ürünler üretebilmek için yoğun Ar-Ge çalışmaları ve teknolojik yatırımları yapmıştır. Teknolojisini sektördeki tecrübesi ile birleştirerek üstün kaliteli ürünler üretmektedir.

HRK's remarkable achievements in Multiwire technology originate from company's intense R&D studies and technological investments. Company manufactures superior quality products by combining its technology with its huge experience in the field.



Plastik Kaplamalı Monotel / Plastic Coated Monowire

HRK, mermer kesiminde kullanılmak üzere Plastik Kaplı Elmas Telleri 10,5 mm, 8,3 mm ve 7,3 mm ebatında 35 ve 37 boncuk seçenekleriyle taşınıza uygun olarak üretmektedir.

HRK tüketici taleplerine göre kullanılacak makinaya uygun olarak sonsuz tel (kapalı çevrim) üretimi ile ürün çeşitliliğini artırmıştır.

Profil makinalarında kullanılan HRK Plastik Kaplamalı Teller uygulanacak olan özel modellerde pürüzsüz yüzey sağlamaktadır.

HRK Plastik Kaplamalı Monoteller granit blok yüzeylerinin düzeltilmesi ve küçültülmesinde hızlı ve verimli üretim sağlamaktadır.

HRK manufactures Plastic Coated Diamond Wires in 10,5 mm, 8,3 mm and 7,3 mm sizes, 35 and 37 beads options according to your stone.

HRK has extended its product range with endless wire (closed circle) production according to consumer demands and the machines to be used.

HRK Plastic Coated Wires used in profile machines enable smooth surfaces in special models to be applied.

HRK Plastic Coated Monowires enable fast and efficient production in smoothing and shrinking granite block surfaces.





Boncuk Ölçüleri (Çap) Bead Size (Diameter)	Boncuk Türü Bead Type	Ürün Cinsi Kind Of Product	Ürün Özellikleri Assembling	Boncuk Sayısı 1 m/Adet Number Of Beads 1 m/Pc	Çevresel Hız m/Saniye Speed Of Rotat. m/Second	Kullanım Alanı Material
10,5 mm	Sinterize / MSL Sinterized / Vacuum Brazed	Plastik Kaplamalı Tel Plastic Coated Wire	Yaylı -Yaysız With Spring - Without Spring	35	28-40	Mermer / Granit / Bazalt / Kuarsit Marble / Granite / Bazalt / Quartzite
9,0 mm	Sinterize / MSL Sinterized / Vacuum Brazed	Plastik Kaplamalı Tel Plastic Coated Wire	Yaysız Without Spring	37	28-40	Mermer / Granit / Bazalt / Kuarsit Marble / Granite / Bazalt / Quartzite
8,3 mm	Sinterize / MSL Sinterized / Vacuum Brazed	Plastik Kaplamalı Tel Plastic Coated Wire	Yaysız Without Spring	37	28-40	Mermer / Granit / Bazalt / Kuarsit Marble / Granite / Bazalt / Quartzite
7,3 mm	Sinterize / MSL Sinterized / Vacuum Brazed	Plastik Kaplamalı Tel Plastic Coated Wire	Yaysız Without Spring	37	28-40	Mermer / Granit / Bazalt / Kuarsit Marble / Granite / Bazalt / Quartzite



Plastik Kaplamalı Ocak Teli / Plastic Coated Quarry Wire

Boncuk Ölçüleri (Çap) Bead Size (Diameter)	Boncuk Türü Bead Type	Ürün Cinsi Kind Of Product	Ürün Özellikleri Assembling	Boncuk Sayısı 1 m/Adet Number Of Beads 1 m/Pc	Çevresel Hız m/Saniye Speed Of Rotat. m/Second	Kullanım Alanı Material
10,5 mm	Sinterize / MSL Sinterized / Vacuum Brazed	Plastik Kaplamalı Tel Plastic Coated Wire	Yaylı -Yaysız With Spring - Without Spring	35	28-40	Mermer / Granit / Kuvarsit Marble / Granite / Quartzite
11,5 mm	Sinterize / MSL Sinterized / Vacuum Brazed	Plastik Kaplamalı Tel Plastic Coated Wire	Yaylı -Yaysız With Spring - Without Spring	37	28-40	Mermer / Granit / Kuvarsit Marble / Granite / Quartzite

HRK, granit kesiminde kullanılmak üzere Plastik Kaplamalı Elmas Telleri 10,5 ve 11,5 mm ebatında, 35 ve 37 boncuklu seçenekleriyle üretmektedir.

HRK manufactures Plastic Coated Diamond Wires with a size of 10,5 and 11,5 mm with 35 and 37 bead choices, in order to be used for cutting granite.

Kauçuk Kaplamalı Ocak Teli / Rubber Coated Quarry Wire

Boncuk Ölçüleri (Çap) Bead Size (Diameter)	Boncuk Türü Bead Type	Ürün Cinsi Kind Of Product	Ürün Özellikleri Assembling	Boncuk Sayısı 1 m/Adet Number Of Beads 1 m/Pc	Çevresel Hız m/Saniye Speed Of Rotat. m/Second	Kullanım Alanı Material
10,5 mm	Sinterize Sinterized	Kauçuk Kaplamalı Tel Rubber Coated Wire	Yaylı -Yaysız With Spring - Without Spring	40	28-35	Granit / Bazalt / Silis Granite / Bazalt / silica
11,5 mm	Sinterize Sinterized	Kauçuk Kaplamalı Tel Rubber Coated Wire	Yaylı -Yaysız With Spring - Without Spring	30	28-35	Granit / Bazalt / Silis Granite / Bazalt / silica
11,5 mm	Sinterize Sinterized	Kauçuk Kaplamalı Tel Rubber Coated Wire	Yaylı -Yaysız With Spring - Without Spring	37	28-35	Granit / Bazalt / Silis Granite / Bazalt / silica

HRK Kauçuk Kaplamalı Teller granit ocaklarında kullanılmak üzere 10,5 mm ve 11,5 mm ebatında, 30, 37 ve 40 boncuklu seçenekleriyle kesim performansını ve verimliliği maksimum düzeyde tutacak şekilde üretilmektedir.

HRK Rubber Coated Wires are manufactured with a size of 10,5 and 11,5 mm, with 30, 37 and 40 bead choices, in a way that keep cutting performance and productivity in maximum level.

Beton Kesim Telleri / Rubber Coated Concrete Wires

Boncuk Ölçüleri (Çap) Bead Size (Diameter)	Boncuk Türü Bead Type	Ürün Cinsi Kind Of Product	Ürün Özellikleri Assembling	Boncuk Sayısı 1 m/Adet Number Of Beads 1 m/Pc	Çevresel Hız m/Saniye Speed Of Rotat. m/Second	Kullanım Alanı Material
10,5 mm	Sinterize / MSL Sinterized / Vacuum Brazed	Kauçuk Kaplamalı Tel Rubber Coated Wire	Yaylı With Spring	40	28-32	Donatılı Beton Reinforced Concrete
10,5 mm	Sinterize / MSL Sinterized / Vacuum Brazed	Kauçuk Kaplamalı Tel Rubber Coated Wire	Yaylı With Spring	48	28-32	Donatılı Beton Reinforced Concrete

Plastik ve kauçuk kaplamalı olarak üretilen HRK beton kesme telleri demir donatılı ve donatısız betonların kesiminde yüksek performans ve maksimum verim sağlamaktadır.

HRK beton kesme telleri standart ürün grubunda 10,5 mm çapında 40 ve 48 boncuklu olarak üretilmektedir.

HRK concrete cutting wires, manufactured with plastic and rubber coatings, enable high performance and maximum efficiency in cutting concrete with or without reinforcement.

HRK concrete cutting wires are manufactured with 40 and 48 beads in the standard product group of a diameter of 10,5 mm.

Metal Kesim Telleri / Rubber Coated Metal Wires

Boncuk Ölçüleri (Çap) Bead Size (Diameter)	Boncuk Türü Bead Type	Ürün Cinsi Kind Of Product	Ürün Özellikleri Assembling	Boncuk Sayısı 1 m/Adet Number Of Beads 1 m/Pc	Çevresel Hız m/Saniye Speed Of Rotat. m/Second	Kullanım Alanı Material
10,5 mm	MSL Vacuum Brazed	Kauçuk Kaplamalı Tel Rubber Coated Wire	Yaylı With Spring	40	28-32	Metal Metal
10,5 mm	MSL Vacuum Brazed	Kauçuk Kaplamalı Tel Rubber Coated Wire	Yaylı With Spring	48	28-32	Metal Metal

HRK Kauçuk Kaplı Metal Kesme Tellerinde, "Vakum Kaplama Yöntemiyle Üretilen Elmas Boncuklar" kullanılmaktadır. Bu tellerin kullanıldığı özel metal kesim alanlarından bazıları şu şekildedir;

- Ömrünü tamamlamış gemilerin kesme ve yıkım uygulamaları
- Petrol Platformlarının sökülmesi ve yıkılması sürecinde
- Geri Dönüşüm Tesislerinde metal kütleleri eritme potalarına gönderebilmek için parçaları daha küçük parçalara kesilmesinde
- Çeşitli endüstrilerde demir, çelik ve diğer birçok metal kesme uygulamalarında

HRK Rubber Coated Metal Cutting Wires are manufactured from highly specialized "Vacuum Brazed Diamond Beads" and commonly used in specific metal cutting applications.

- Cutting & demolition applications of end-of-life Ships.
- During the dismantling and demolition process of Petroleum Platforms.
- In Recycling Plants cutting the parts to smaller pieces to be able to send them melting pots as well as other recycling plant cutting applications.
- Iron, steel and many other metals cutting applications in various industries.



POWERPLUS

EXtra

Telin ömrü artık çok uzun!

The life of wire is much longer!

PowerPlus ve **Extra** Mermer Kesme Teli firmamızın Ar-Ge çalışmaları sonucunda geliştirdiği ve geniş ürün yelpazesine dahil ettiği bir üründür.

PowerPlus ve **Extra** Mermer Kesme Tellerinin temel özelliği; kullanılan ekipmanların dış etkenlere karşı yüksek dayanım göstermesi, korozyon ve aşınmadan kaynaklı halat kopmalarını azaltmasıdır.

Bu sayede ocaklarda sık sık yaşanan halat kopmalarından kaynaklı iş kazalarını minimuma indirmektedir. Özellikle tuzlu sularla çalışılan ocaklarda malzemelerin çok daha uzun ömürlü olmasını sağlamaktadır.

PowerPlus uygun kullanım şartları sağlandığında hiç dizim gerektirmeden maksimum verimle çalışma olanağı sağlayabilmektedir.

PowerPlus and **Extra** Marble Cutting Wire is a product that our company developed in consequence of R&D studies and included in the wide range of products.

The key feature of **PowerPlus** and **Extra** Marble Cutting Wires is that the equipments used are highly resistant to external factors and decrease rope breakage arising from corrosion and abrasion.

Therefore, it minimizes occupational accidents that often occur in mines due to rope breakage. Especially in mines operating with salt water, it enables longer life for equipments.

PowerPlus under proper working conditions, it can ensure the opportunity with maximum performance, without the need for composition.

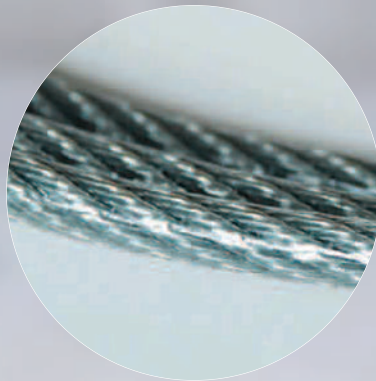

Yaylı Tel (Sulu Kesim) / Wire with Spring (Wet Cutting)

Boncuk Ölçüleri (Çap) Bead Size (Diameter)	Ürün Cinsi Kind Of Product	Ürün Özellikleri Assembling	Boncuk Sayısı 1 m/Adet Number Of Beads 1 m/Pc	Çevresel Hız m/Saniye Speed Of Rotat. m/Second	Bej Mermer/Beige Marble		Traverten/Travertine		Limra/Limestone	
					Kesim Hızı m2/Saat Cutting Speed m2/Hour	Kesim Ömrü m2/m Production m2/m	Kesim Hızı m2/Saat Cutting Speed m2/Hour	Kesim Ömrü m2/m Production m2/m	Kesim Hızı m2/Saat Cutting Speed m2/Hour	Kesim Ömrü m2/m Production m2/m
11 mm	Speedy	Yaylı Sulu Kesim Spring-Wet Cutting	27	45	9-13	50-70	12-16	60-80	14-18	70-90
11 mm	Speedy	Yaylı Sulu Kesim Spring-Wet Cutting	30	45	7-12	60-80	10-14	70-90	12-16	80-100
12 mm	Speedy	Yaylı Sulu Kesim Spring-Wet Cutting	27	45	8-12	60-80	11-15	70-90	13-17	80-100
12 mm	Speedy	Yaylı Sulu Kesim Spring-Wet Cutting	30	45	6-11	70-90	9-13	80-100	11-15	90-110

Boncuk Ölçüleri (Çap) Bead Size (Diameter)	Ürün Cinsi Kind Of Product	Ürün Özellikleri Assembling	Boncuk Sayısı 1 m/Adet Number Of Beads 1 m/Pc	Çevresel Hız m/Saniye Speed Of Rotat. m/Second	Bej Mermer/Beige Marble		Silisli Taşlar/Siliceous Stone		Sert Taşlar/Hard Stones	
					Kesim Hızı m2/Saat Cutting Speed m2/Hour	Kesim Ömrü m2/m Production m2/m	Kesim Hızı m2/Saat Cutting Speed m2/Hour	Kesim Ömrü m2/m Production m2/m	Kesim Hızı m2/Saat Cutting Speed m2/Hour	Kesim Ömrü m2/m Production m2/m
11 mm	Speedy Plus	Yaylı Sulu Kesim Spring-Wet Cutting	27	45	9-13	70-100	9-13	70-90	7-11	70-90
11 mm	Speedy Plus	Yaylı Sulu Kesim Spring-Wet Cutting	30	45	7-12	90-120	8-12	80-100	6-10	80-100
12 mm	Speedy Plus	Yaylı Sulu Kesim Spring-Wet Cutting	27	45	8-12	90-120	8-12	80-100	6-10	80-100
12 mm	Speedy Plus	Yaylı Sulu Kesim Spring-Wet Cutting	30	45	6-11	100-130	7-11	90-110	5-9	90-110



HRK Yaylı Sulu Kesim Teli doğal taş kesiminde yüksek hız ve minimum maliyetle ihtiyacınıza cevap vermektedir.

Firmamız, geniş ürün yelpazesi sayesinde kesim zorluğu yaşanan, aşındırıcı, silisli, kuartzlı taşların kesiminde alternatif çözümler sunmaktadır.

Ortalama kesim ömrü ve hız verileri tablolarda belirtilmektedir. Bu veriler, kullanılacak makineye, kesilecek taş ebatına ve çalışma şartlarına göre değişkenlik gösterebilmektedir.

HRK Spring Wet Cutting Wire fulfills your needs in cutting natural stones with high speed and minimum cost.

With its wide range of products, our company offers alternative solutions for cutting difficult, abrasive, siliceous, quartz stones.

Average cutting life and speed data is specified in tables. Such data may vary depending on the machine to be used, size of the stone to be cut and working conditions.

Yaylı Tel (Kuru Kesim) / Wire with Spring (Dry Cutting)

Boncuk Ölçüleri (Çap) Bead Size (Diameter)	Ürün Cinsi Kind Of Product	Ürün Özellikleri Assembling	Boncuk Sayısı 1 m/Adet Number Of Beads 1 m/Pc	Çevresel Hız m/Saniye Speed Of Rotat. m/Second	Bej Mermer/Beige Marble		Traverten/Travertine		Limra/Limestone	
					Kesim Hızı m2/Saat Cutting Speed m2/Hour	Kesim Ömrü m2/m Production m2/m	Kesim Hızı m2/Saat Cutting Speed m2/Hour	Kesim Ömrü m2/m Production m2/m	Kesim Hızı m2/Saat Cutting Speed m2/Hour	Kesim Ömrü m2/m Production m2/m
11 mm	Classic	Yaylı Kuru Kesim Spring-Dry Cutting	27	45	8-12	50-80	9-13	70-90	10-14	70-100
12 mm	Classic	Yaylı Kuru Kesim Spring-Dry Cutting	27	45	6-10	60-90	7-11	80-100	8-12	80-110
11 mm	Premium	Yaylı Kuru Kesim Spring-Dry Cutting	27	45	8-12	60-90	9-13	80-100	10-14	80-110
12 mm	Premium	Yaylı Kuru Kesim Spring-Dry Cutting	27	45	6-10	70-100	7-11	90-110	8-12	90-120

HRK Kuru Kesim Telleri suya ulaşımın zor olduğu ocaklara ve kış aylarında ağır çalışma şartlarına alternatif çözüm olarak üretilmektedir.

Ortalama kesim ömrü ve hız verileri tablolarda belirtilmektedir. Bu veriler, kullanılacak makineye, kesilecek taş ebatına ve çalışma şartlarına göre değişkenlik gösterebilmektedir.

HRK Dry Cutting Wires are manufactured as an alternative solution to heavy working conditions in mines where access to water is hard and in winter months.

Average cutting life and speed data is specified in tables. Such data may vary depending on the machine to be used, size of the stone to be cut and working conditions.

Yaylı MSL Tel (Sulu Kesim - Kuru Kesim) MSL Wire with Spring (Wet Cutting - Dry Cutting)

Boncuk Ölçüleri (Çap) Bead Size (Diameter)	Boncuk Türü Bead Type	Ürün Cinsi Kind Of Product	Ürün Özellikleri Assembling	Boncuk Sayısı 1 m/Adet Number Of Beads 1 m/Pc	Çevresel Hız m/Saniye Speed Of Rotat. m/Second	Kullanım Alanı Material
10,5 mm	MSL / Vacum Brazed	Yaylı / With Spring	Sulu - Kuru Kesim Çiftli Wet - Dry Cutting	25	40-45	Mermer / Marble
10,5 mm	MSL / Vacum Brazed	Yaylı / With Spring	Sulu - Kuru Kesim Wet - Dry Cutting	27	40-45	Mermer / Marble
10,5 mm	MSL / Vacum Brazed	Yaylı / With Spring	Sulu - Kuru Kesim Wet - Dry Cutting	32	40-45	Mermer / Marble

MSL Vakum Brazed Elmas Boncuklar, Hartek'in son teknoloji ürünleri olarak sizlere sunulmuştur. Bu elmas boncuklar, firmanın daimi ve kararlı Ar-Ge çalışmalarının ve teknik ekibinin yüksek vizyonunun sonucudur. MSL Teller, kesim hızında hatırı sayılır bir artış hedefleyerek doğal taş ocak ve fabrika işletmelerine önemli ölçüde maliyet avantajı sunmaktadır.

MSL Vacuum Brazed Diamond Beads are the latest technology products of Hartek company. These beads are the result of strong and permanent R&D studies through the high vision of the technical team. MSL Wires target remarkable increase in the cutting speed, so that bring great cost advantage for stone miners and fabricators.

Yaylı Tel (Sulu Kesim) / Wire with Spring (Wet Cutting)

Boncuk Ölçüleri (Çap) Bead Size (Diameter)	Ürün Cinsi Kind Of Product	Ürün Özellikleri Assembling	Boncuk Sayısı 1 m/Adet Number Of Beads 1 m/Pc	Çevresel Hız m/Saniye Speed Of Rotat. m/Second	Bej Mermer/Beige Marble		Traverten/Travertine		Limra/Limestone	
					Kesim Hızı m2/Saat Cutting Speed m2/Hour	Kesim Ömrü m2/m Production m2/m	Kesim Hızı m2/Saat Cutting Speed m2/Hour	Kesim Ömrü m2/m Production m2/m	Kesim Hızı m2/Saat Cutting Speed m2/Hour	Kesim Ömrü m2/m Production m2/m
11 mm	Diabond	Yaylı Sulu Kesim Spring-Wet Cutting	27	45	9-13	50-70	12-16	60-80	14-18	70-90
11 mm	Diabond	Yaylı Sulu Kesim Spring-Wet Cutting	30	45	7-12	60-80	10-14	70-90	12-16	80-100
12 mm	Diabond	Yaylı Sulu Kesim Spring-Wet Cutting	27	45	8-12	60-80	11-15	70-90	13-17	80-100
12 mm	Diabond	Yaylı Sulu Kesim Spring-Wet Cutting	30	45	6-11	70-90	9-13	80-100	11-15	90-110

Boncuk Ölçüleri (Çap) Bead Size (Diameter)	Ürün Cinsi Kind Of Product	Ürün Özellikleri Assembling	Boncuk Sayısı 1 m/Adet Number Of Beads 1 m/Pc	Çevresel Hız m/Saniye Speed Of Rotat. m/Second	Bej Mermer/Beige Marble		Traverten/Travertine		Limra/Limestone	
					Kesim Hızı m2/Saat Cutting Speed m2/Hour	Kesim Ömrü m2/m Production m2/m	Kesim Hızı m2/Saat Cutting Speed m2/Hour	Kesim Ömrü m2/m Production m2/m	Kesim Hızı m2/Saat Cutting Speed m2/Hour	Kesim Ömrü m2/m Production m2/m
11 mm	Diabond Premium	Yaylı Sulu Kesim Spring-Wet Cutting	27	45	9-13	60-80	12-16	70-90	14-18	80-100
11 mm	Diabond Premium	Yaylı Sulu Kesim Spring-Wet Cutting	30	45	7-12	70-90	10-14	80-100	12-16	90-110
12 mm	Diabond Premium	Yaylı Sulu Kesim Spring-Wet Cutting	27	45	8-12	70-90	11-15	80-100	13-17	90-110
12 mm	Diabond Premium	Yaylı Sulu Kesim Spring-Wet Cutting	30	45	6-11	80-100	9-13	90-110	11-15	100-120

Diabond elmaslı kesici teller serbest sinterleme yöntemiyle üretilen ekonomik seri ürünlerimizdir. Sulu kesim uygulamalarında fiyat performans açısından beklentileri karşılamaktadır.

Ortalama kesim ömrü ve hız verileri tablolarda belirtilmektedir. Bu veriler, kullanılacak makineye, kesilecek taş ebatına ve çalışma şartlarına göre değişkenlik gösterebilmektedir.

Diabond Wire is our economic series product manufactured by free sintering method. Diabond meets the expectations in wet cutting applications in terms of price performance.

Average cutting life and speed data is specified in tables. Such data may vary depending on the machine to be used, size of the stone to be cut and working conditions.



Aksesuarlar / Accessories



HRK çelik halat, yay, pul, sıkma, ikili ek, bakır ek, su sacı tel sıkma ve kesme makası gibi ocak yardımcı malzemelerini kaliteden taviz vermeden ve tüketici güvenliğini göz önünde bulundurarak tedarik etmektedir.

HRK supplies auxiliary mine equipments such as steel rope, spring, washer, clamping, double attachment, copper attachment, water sheet wire clamping and cutting scissors considering consumer safety and without sacrificing quality.



Aksesuarlar / Accessories



Çelik Halat
(Standard-Extra-Power Plus)

Steel Rope
(Standard-Extra-Power Plus)
Ø 4,90 mm (19+6x7)



Bakır Ek
Copper Joint
Ø 9/5 x 30 mm
Ø 9/5 x 25 mm
Ø 7/4 x 25 mm



Yay / Spring
24 mm - 30 mm

Değişik ölçülerde üretim yapılabilir.
Various sizes are available.



Ocak Karot Ucu
Drilling tools for quarry
Ø 43,5 mm



Pul / Spacer
Ø 8 x 3 mm
Ø 8 x 4 mm



Kompozit Kasnak
Composite Flywheel
Ø 500 - Ø 800



Sıkma / Lock
Ø 8 x 6 mm
Ø 9 x 6 mm



Alüminyum Kasnak
Aluminum Flywheel
Ø 500 - Ø 800



İkili Ek
Steel Joint With Two Pieces
Ø 9 x 30 mm



Kasnak Lastiği
Rubber Flywheel
Ø 500 - Ø 800



Demir Ek
Steel Joint
Ø 8 x 30 mm



Mermer Çivisi
Wedges
35 cm

Aksesuarlar / Accessories



Su Sacı
Hydro Bag
100 x 100 cm
120 x 120 cm



Permon Bit
Permon Tabanca
DTH Drills and Bits



Su Sacı Pompası
Hydro Bag Pump
200 bar



Bit
Tabanca
DTH Drills and Bits



Hidrolik Kesme-Sıkma Presi
Hydraulic Cutting and Pressing



Bit
Tabanca
DTH Drills and Bits

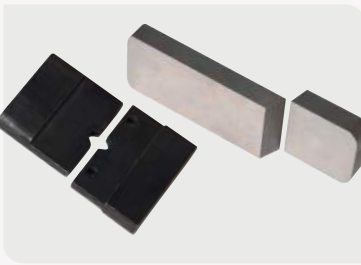

Hidrolik Kesme-Sıkma Presi Ekipmanları
Hydraulic Cutting and Pressing Equipments



El Tabancası
Rock Drill
Y20 - Y24 - YT28



Tel Kesme Makası
Hand press for cutting

Tel Sıkma Makası
Hand press



Integral Matkap
80 cm - 160 cm - 240 cm
320 cm - 400 cm

Integral Drill Rod
80 cm - 160 cm - 240 cm
320 cm - 400 cm



Hidrolik El Sıkma Presi
Hydraulic Crimping Tools



Sabit, Manuel
Tel Sıkma Presi
Fixed, Manual Hand Press

Zincirli Kesme Uçları / Chain Saw Segments



Kare Tungsten Karbür
12,7 x 12,7 x 6,5 mm
13,1 x 13,1 x 7,0 mm
Square Tungstene Carbide
12,7 x 12,7 x 6,5 mm
13,1 x 13,1 x 7,0 mm



Pimli Yuvarlak Pdc
Ø 13,40 mm
Round Pdc with Pin
Ø 13,40 mm



Yıldız Tungsten Karbür
6,5 mm
7,0 mm
Star Tungstene Carbide
6,5 mm
7,0 mm



Kater - Yuvarlak
Pdc Holder

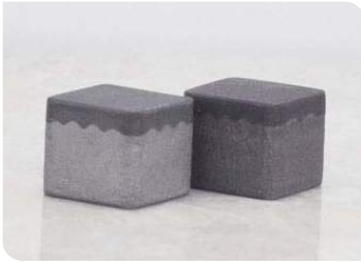

Kare Pdc
9,4 x 9,4 x 8 mm
Square Pdc
9,4 x 9,4 x 8 mm



Kater - Tekli Kare
Pdc Holder



Yuvarlak Pdc
Ø 13,40 mm
Round Pdc
Ø 13,40 mm



Kater - Çiftli Kare
Pdc Holder



Vidalı Kare Pdc
9,4 x 9,4 mm
Square Pdc with Screw
9,4 x 9,4 mm



Kollu Kesme Zincir (Erkek)
Chain Saw Insert (Male)



Vidalı Yuvarlak Pdc
Ø 13,40 mm
Round Pdc with Screw
Ø 13,40 mm



Kollu Kesme Zincir (Dişi)
Chain Saw Insert (Female)

Katrak Lamaları / Gangsaw Blades

HRK Katrak Lamaları mermer ve traverten için Konik Sandviç ve V Tipi Konik Sandviç soket çeşitleriyle uzun ömürlü, yüksek hızlı ve en az maliyetli kesim sağlamaktadır.

HRK Katrak Soketleri 2 mm, 2,5 mm, 3 mm ve 3,5 mm sac kalınlıklarına uygun olarak tüketici taleplerine göre üretilmektedir.

HRK Katrak Lama Saclarında eğim ve gerilim kontrolü yapıldıktan sonra otomatik kaynak makinalarıyla soket kaynak işlemi yapılmaktadır. Bu sayede kaliteli ürün standardında devamlılık sağlanmaktadır.

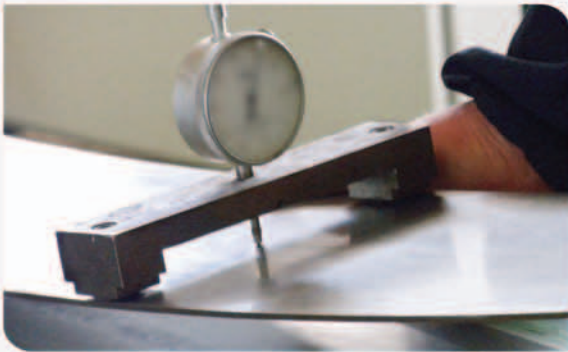

HRK Gangsaw Blades ensure long-lasting, high speed and lowest-cost cutting with its Conical Sandwich and V-Type Conical Sandwich segments for marble and travertine.

HRK Gangsaw segments are manufactured upon consumer demands in accordance with 2 mm, 2,5 mm, 3 mm and 3,5 mm sheet thicknesses.

After slope and tension controls of HRK Gangsaw Blades are performed, segment welds are made with automatic welding machines.

Therefore, continuity in quality product standard is ensured.

HRK
GANGSAW BLADES





KATRAK LAMASI / GANGSAW BLADES

Makina Türü Type of Machine	Makina Devir Hızı RPM	Kullanım Alanı Material	Kesim Hızı Cutting Speed	Soket Sayısı Number of Segment
Yüksek Devir High Speed	100-110 Devir / RPM 80 Strok / Stroke	Bej Mermer / Beige Marble	25-35 cm/saat - cm/hour	28-30
		Traverten / Travertine Yumuşak Mermer / Soft Marble	35-55 cm/saat - cm/hour	28-32
Düşük Devir Low Speed	80-90 Devir / RPM 60 Strok / Stroke	Bej Mermer / Beige Marble	18-25 cm/saat - cm/hour	28-30
		Traverten / Travertine Yumuşak Mermer / Soft Marble	25-35 cm/saat - cm/hour	28-32

KATRAK LAMALARININ HAZIRLANMASINDA İHTİYAÇ DUYULAN TEKNİK VERİLER

- 1- Katrak makinasının modeli (dakikadaki strok sayısı ana motor gücü ve kesim hareket boyu)
- 2- Kullanılacak katrak lama sacının uzunluğu
- 3- Kullanılacak katrak lama sacının kalınlığı
- 4- Kullanılacak katrak lama sacı sayısı
- 5- Kesilecek mermerin plaka kalınlığı
- 6- Kesilecek mermerin cinsi

REQUIRED TECHNICAL DATA FOR PRODUCTION OF GANGSAW BLADES

- 1- Type of machine (Strokes per minute, main motor power, movement of cutting length)
- 2- Length of the blade (mm)
- 3- Blade thickness
- 4- Number of blades
- 5- Thickness of marble slabs
- 6- Type of material to be cut

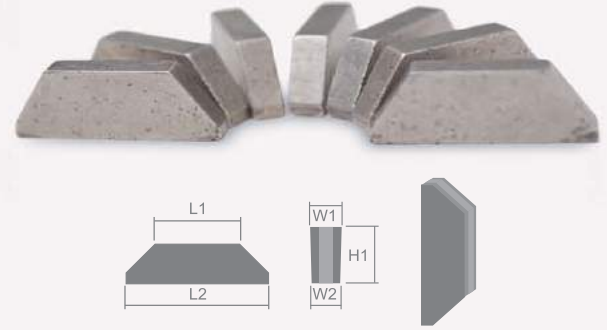
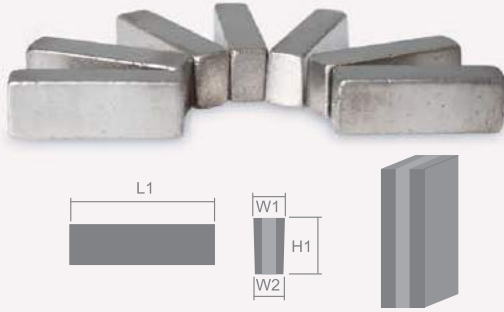

Model	Taş Cinsi Type of Stone	Çelik Gövde Steel Body			Soket Ölçüsü Size of Segment		
		L	W	T	W1-W2	H1	L1
Konik Sandviç Conic Sandwich	Mermer Traverten Marble Travertine	180/200	4050	2	3,6-3,0	8	20
			4160				
			4200	2,5	4,1-3,5	8	20
			4300				
			4350	3	5,1-4,5	8	20
			4400				
4460	3,5	5,5-4,9	8	20			
4490							

Model	Taş Cinsi Type of Stone	Çelik Gövde Steel Body			Soket Ölçüsü Size of Segment		
		L	W	T	W1-W2	H1	L1-L2
V Tipi Konik Sandviç V Type Conic Sandwich	Emperador	180/200	4050	2	3,6-3,0	7	16-28
			4160				
			4200	2,5	4,1-3,5	7	16-28
			4300				
			4350	3	5,1-4,5	7	16-28
			4400				
4460	3,5	5,5-4,9	7	16-28			
4490							

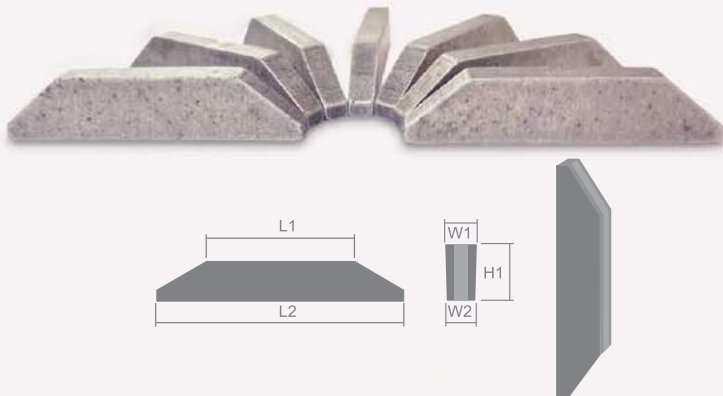

Model	Taş Cinsi Type of Stone	Çelik Gövde Steel Body			Soket Ölçüsü Size of Segment		
		L	W	T	W1-W2	H1	L1-L2
V Tipi Konik Sandviç V Type Conic Sandwich	Traverten Travertine	180/200	4050	2	3,6-3,0	8	30-50
			4160				
			4200	2,5	4,1-3,5	8	30-50
			4300				
			4350	3	5,1-4,5	8	30-50
			4400				
4460	3,5	5,5-4,9	8	30-50			
4490							

Granit Multiblade Testereleri / Granite Multiblades

HRK Multiblade Testerelerinin üretiminde ürün standardını esas almaktadır ve bu amaç ile gerekli yatırımlarını tamamlamıştır. Otomatik kaynak, otomatik gerilim ve balans makinaları kullanılarak yüksek kalite standardında ürünler üretmektedir. Üretim hattından çıkan testerelerin tümü gerilim kalite kontrol raporu ile birlikte müşteriye teslim edilmektedir.

HRK takes product standards as the basis in the production of its Multiblade Saws, and has completed necessary investments for this purpose. Products with high quality standards are manufactured by using automatic welding, automatic voltage and balance machines. All saws from the production line are delivered to the customer with voltage quality control report.

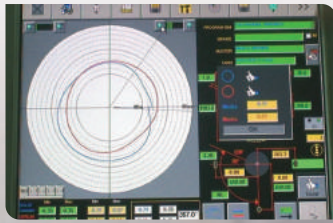

GRANİT MULTIBLADE TESTERELERİ GRANITE MULTIBLADES

Testere Çapı Diameter of The Saw	Testere Tipi Type of Saw	Soket Boyutları Gen. x Yüks. x Uz. Size of Segment W x H x L	Soket Sayısı Number of Segment
1000 mm	Multiblade	7.1-6,0x12,5x24 7,0-6,0x15x24	70
1100 mm	Multiblade	7.6-6,5x12,5x24 7,5-6,5x15x24	74
1200 mm	Multiblade	7.6-6,5x12,5x24 7,5-6,5x15x24	80
1250 mm	Multiblade	7.6-6,5x12,5x24 7,5-6,5x15x24	84
1300 mm	Multiblade	7.6-6,5x12,5x24 7,5-6,5x15x24	88
1400 mm	Multiblade	8.1-7,0x12,5x24 8,0-7,0x15x24	92
1500 mm	Multiblade	8.1-7,0x12,5x24 8,0-7,0x15x24	100
1600 mm	Multiblade	8.1-7,0x12,5x24 8,0-7,0x15x24	104
1700 mm	Multiblade	9.1-8,0x12,5x24 9-8,0x15x24	112
1750 mm	Multiblade	9.1-8,0x12,5x24 9-8,0x15x25	112
1800 mm	Multiblade	9.6-8,5x12,5x24 9,5-8,5x15x24	120
2000 mm	Multiblade	10.1-9,0x12,5x24 10,0-9,0x15x24	132

Granit ST Testere / Granite ST Blades

GRANİT-BAZALT-ANDEZİT VE DİĞER DOĞAL TAŞLAR KESME TESTERELERİ
GRANITE-BASALT-ANDESİTE AND OTHER NATURAL STONES CUTTING SAWS

Testere Çapı Diameter of The Saw	Sac Cinsi Type of Saw	Soket Boyutları Gen. x Yüks. x Uz. Size of Segment W x H x L	Soket Sayısı Number of Segment
900 mm	Normal	7,6-6,5x12,5x24	64
		7,5-6,5x15x24	
1000 mm	Normal	8,1-7,0x12,5x24	70
		8,6-7,5x12,5x24	
		8,0-7,0x15x24	
		8,5-7,5x15x24	
1100 mm	Normal	8,6-7,5x12,5x24	74
		9,1-8,0x12,5x24	
		8,5-7,5x15x24	
		9,0-8,0x15x24	
1200 mm	Normal	8,6-7,5x12,5x24	80
		9,1-8,0x12,5x24	
		8,5-7,5x15x24	
		9,0-8,0x15x24	
1300 mm	Normal	9,1-8,0x12,5x24	88
		9,6-8,5x12,5x24	
		9,0-8,0x15x24	
		9,5-8,5x15x24	
1400 mm	Normal	9,1-8,0x12,5x24	92
		9,6-8,5x12,5x24	
		9,0-8,0x15x24	
		9,5-8,5x15x24	
1500 mm	Normal	9,6-8,5x12,5x24	100
		10,1-9x12,5x24	
		9,5-8,5x15x24	
		10,0-9,0x15x24	
1600 mm	Normal	10,1-9x12,5x24	108
		10,6-9,5x12,5x24	
		10,0-9,0x15x24	
		10,5-9,5x15x24	
1700 mm	Normal	10,1-9x12,5x24	112
		10,6-9,5x12,5x24	
		10,0-9,0x15x24	
		10,5-9,5x15x24	
		10,1-9x12,5x24	
1750 mm	Normal	10,6-9,5x12,5x24	112
		11,1-10x12,5x24	
		10,0-9,0x15x24	
		10,5-9,5x15x24	
		11,0-10,0x15x24	
1800 mm	Normal	10,6-9,5x12,5x24	120
		11,1-10x12,5x24	
		11,6-10,5x12,5x24	
		10,5-9,5x15x24	
		11,0-10,0x15x24	
		11,5-10,5x15x25	
		11,1-10x12,5x24	
2000 mm	Normal	11,6-10,5x12,5x24	132
		12,1-11x12,5x24	
		11,0-10,0x15x24	
		11,5-10,5x15x25	
		12,0-11,0x15x24	
2100 mm	Normal	11,6-10,5x12,5x24	138
		12,1-11x12,5x24	
		11,6-10,5x15x24	
		12,1-11x15x24	
2200 mm	Normal	12,1-11x12,5x25	140
		12,6-11,5x12,5x24	
		12,1-11x15x25	
		12,6-11,5x15x24	

ST GRANİT TESTERELERİ DEVİR TABLOSU
ST GRANITE BLADES ROTATION TABLE

Çap Diameter	Flanş Çapı Diameter of Flange	Çevresel Hız m/ Saniye / Peripheral Speed m/Second				
		25	30	35	40	45
900	250	531	637	743	849	955
950	250	503	603	704	805	905
1000	250	478	573	669	764	860
1100	250	434	521	608	695	782
1200	300	398	478	557	637	717
1250	300	382	459	535	611	688
1300	300	367	441	514	588	661
1400	300	341	409	478	546	614
1500	300	318	382	446	510	573
1600	300	299	358	418	478	537
1650	350	290	347	405	463	521
1700	350	281	337	393	450	506
1750	350	273	328	382	437	491
1800	400	265	318	372	425	478
2000	400	239	287	334	382	430
2000	400	239	287	334	382	430
2100	400	228	273	318	364	410
2200	450	207	249	290	331	373

Mermer ST Testereleri / Marble ST Blades



ST MERMER TESTERELERİ DEVİR TABLOSU / ST MARBLE BLADES ROTATION TABLE

Çap Diameter	Flanş Çapı Diameter of Flange	Çevresel Hız m/Saniye / Peripheral Speed m/Second					
		Sert Taşlar / Hard Stones		Orta Sert Taşlar / Middle Hard Stones		Yumuşak Taşlar / Soft Stones	
		45	50	55	60	65	70
900	250	956	1062	1168	1274	1380	1486
950	250	905	1006	1106	1207	1307	1408
1000	250	860	955	1051	1146	1242	1338
1100	250	782	869	955	1042	1129	1216
1200	300	717	796	876	955	1035	1115
1250	300	688	764	841	917	994	1070
1300	300	661	735	808	882	955	1029
1400	300	614	682	751	819	887	955
1500	300	573	637	701	764	828	892
1600	300	537	597	657	717	776	836
1650	350	521	579	637	695	753	811
1700	350	506	562	618	674	731	787
1750	350	491	546	601	655	710	764
1800	400	477	531	584	637	690	743
2000	400	430	478	525	573	621	669
2100	400	410	455	500	546	591	637
2200	450	373	414	455	497	538	580

HRK 900 mm'den 2200 mm'ye kadar ihtiyacınıza uygun şekilde ST Mermer Testerelerini üretmektedir.

HRK tüketici memnuniyetini esas alarak, mermerin çeşidine göre hassas ve hızlı kesim için özel hazırlanmış soketlerle kaliteli ürün elde edilmesini sağlamaktadır.

HRK manufactures ST Marble Saws from 900 mm to 2200 mm in accordance with your needs.

Taking consumer satisfaction as the basis, HRK ensures the production of quality materials especially prepared for precise and rapid cutting according to the type of marble.

Firmamız makina parkında bulunan otomatik gerilim makinalarıyla testerelerin kalite kontrolünü ön planda tutmaktadır.

Our company gives particular importance to the quality controls of automatic tension machines and saws in machine park.



Testere Çapı Diameter of The Saw	Testere Tipi Type of Saw	Soket Boyutları Gen. x Yüks. x Uz. Size of Segment W x H x L	Soket Sayısı Segment Number
900 mm	Standard	7x8x30	64
900 mm	Standard	8x8x30	64
1000 mm	Standard	7x8x24	70
1000 mm	Standard	7x8x30	70
1000 mm	Standard	7x8x40	70
1000 mm	Standard	8x8x24	70
1000 mm	Standard	8x8x30	70
1000 mm	Standard	8x8x40	70
1100 mm	Standard	7x8x24	74
1100 mm	Standard	7x8x30	74
1100 mm	Standard	7x8x40	74
1100 mm	Standard	8x9x24	74
1100 mm	Standard	8x9x30	74
1100 mm	Standard	8x8x40	74
1200 mm	Standard	8x9x24	80
1200 mm	Standard	8x9x30	80
1200 mm	Standard	8x8x40	80
1250 mm	Standard	8x9x24	84
1250 mm	Standard	8x9x30	84
1250 mm	Standard	8x8x40	84
1300 mm	Standard	9x8x24	88
1300 mm	Standard	9x8x30	88
1300 mm	Standard	9x10x24	88
1300 mm	Standard	9x10x30	88
1400 mm	Standard	9x8x24	92
1400 mm	Standard	9x8x30	92
1400 mm	Standard	9x10x24	92
1400 mm	Standard	9x10x30	92
1500 mm	Standard	9x8x24	100
1500 mm	Standard	9x8x30	100
1500 mm	Standard	9x10x24	100
1500 mm	Standard	9x10x30	100
1600 mm	Standard	10x9x24	104
1600 mm	Standard	10x9x30	104
1600 mm	Standard	10x11x24	104
1600 mm	Standard	10x11x30	104
1650 mm	Standard	10x9x24	108
1650 mm	Standard	10x9x30	108
1650 mm	Standard	10x11x24	108
1650 mm	Standard	10x11x30	108
1700 mm	Standard	10x9x24	112
1700 mm	Standard	10x9x30	112
1700 mm	Standard	10x11x24	112
1700 mm	Standard	10x11x30	112
1750 mm	Standard	10x9x24	112
1750 mm	Standard	10x9x30	112
1750 mm	Standard	10x11x24	112
1750 mm	Standard	10x11x30	112
1800 mm	Standard	10x9x24	120
1800 mm	Standard	10x9x30	120
1800 mm	Standard	10x11x24	120
1800 mm	Standard	10x11x30	120
2000 mm	Standard	10x12x24	132
2100 mm	Standard	11x12x24	138
2200 mm	Standard	12x13x24	140

Granit Yatay Testereleri / Granite Horizontal Blades

ST YATAY TESTERELERİ ST HORIZONTAL BLADES

Testere Çapı Diameter of the Saw	Sac Cinsi Sheet Type	Soket Boyutları Size of Segment W x H x L	Soket Sayısı Number of Segment
400 mm	Seyrek / Wide	5,5x10x40	24
400 mm	Seyrek / Wide	6,5x10x40	24
400 mm	Seyrek / Wide	8x8x40	24
450 mm	Seyrek / Wide	5,5x10x40	26
450 mm	Seyrek / Wide	6,5x10x40	26
450 mm	Seyrek / Wide	8x8x40	26
500 mm	Seyrek / Wide	5,5x10x40	30
500 mm	Seyrek / Wide	6,5x10x40	30
500 mm	Seyrek / Wide	8x8x40	30
550 mm	Seyrek / Wide	5,5x10x40	32
550 mm	Seyrek / Wide	6,5x10x40	32
550 mm	Seyrek / Wide	8x8x40	32
600 mm	Seyrek / Wide	5,5x10x40	36
600 mm	Seyrek / Wide	6,5x10x40	36
600 mm	Seyrek / Wide	8x8x40	36

ST GÜÇLENDİRİLMİŞ (KADEMELİ) YATAY TESTERELERİ ST REINFORCED HORIZONTAL SAWS

Testere Çapı Diameter of the Saw	Sac Cinsi Sheet Type	Soket Boyutları Size of Segment W x H x L	Soket Sayısı Number of Segment
400 mm	3,5-7mm	6,5x10x40	24
400 mm	3,5-7mm	8x8x40	24
450 mm	3,5-7mm	6,5x10x40	26
450 mm	3,5-7mm	8x8x40	26
500 mm	3,5-7mm	6,5x10x40	30
500 mm	3,5-7mm	8x8x40	30
550 mm	3,5-7mm	6,5x10x40	32
550 mm	3,5-7mm	8x8x40	32
600 mm	3,5-7mm	6,5x10x40	36
600 mm	3,5-7mm	8x8x40	36

HRK Granit Yatay Testereleri 400 mm çaptan 650 mm çapa kadar olan ebatlarıyla, birçok elmas soket ölçüsü ve güçlendirilmiş (kademeli) seçenekleriyle üreticilerin hizmetine sunulmuştur.

HRK Granite Horizontal Blades are manufactured with the diameters from 400 mm to 650 mm with various segment size and reinforced options. This product group serves as a strong assistant to stone fabricators.

Mermer Yatay - Yarma Testereleri

Marble Horizontal - Splitting Blades



ST YATAY TESTERELER / ST HORIZONTAL BLADES

Testere Çapı Diameter of The Saw	Testere Tipi Type of Saw	Soket Boyutları Gen. x Yüks. x Uz. Size of Segment W x H x L	Soket Sayısı Number of Segment
400 mm	Seyrek / Wide	5,5x7x40	24
450 mm	Seyrek / Wide	5,5x7x40	26
500 mm	Seyrek / Wide	5,5x7x40	30

YATAY TESTERELER / HORIZONTAL BLADES

Testere Çapı Diameter of The Saw	Testere Tipi Type of Saw	Soket Boyutları Gen. x Yüks. x Uz. Size of Segment W x H x L	Soket Sayısı Number of Segment
625 mm	Seyrek / Wide	5,5x7x40	36
625 mm	Seyrek / Wide	6x7x40	36
650 mm	Seyrek / Wide	5,5x7x40	38
650 mm	Seyrek / Wide	6x7x40	38
650 mm	Seyrek / Wide	6,5x7x40	38
700 mm	Seyrek / Wide	5,5x7x40	40
700 mm	Seyrek / Wide	6x7x40	40
700 mm	Seyrek / Wide	6,5x7x40	40
725 mm	Seyrek / Wide	5,5x7x40	40
725 mm	Seyrek / Wide	6x7x40	40
725 mm	Seyrek / Wide	6,5x7x40	40
750 mm	Seyrek / Wide	6x7x40	40
750 mm	Seyrek / Wide	6,5x7x40	40
800 mm	Seyrek / Wide	6x7x40	46
800 mm	Seyrek / Wide	6,5x7x40	46
850 mm	Seyrek / Wide	6x7x40	50
850 mm	Seyrek / Wide	6,5x7x40	50
900 mm	Seyrek / Wide	6,5x7x40	64
625 mm	Sık / Narrow	5,5x7x40	42
625 mm	Sık / Narrow	6x7x40	42
650 mm	Sık / Narrow	5,5x7x40	46
650 mm	Sık / Narrow	6x7x40	46
650 mm	Sık / Narrow	6,5x7x40	46
700 mm	Sık / Narrow	5,5x7x40	50
700 mm	Sık / Narrow	6x7x40	50
700 mm	Sık / Narrow	6,5x7x40	50
725 mm	Sık / Narrow	5,5x7x40	50
725 mm	Sık / Narrow	6x7x40	50
725 mm	Sık / Narrow	6,5x7x40	50
750 mm	Sık / Narrow	6x7x40	50
750 mm	Sık / Narrow	6,5x7x40	50
800 mm	Sık / Narrow	6x7x40	57
800 mm	Sık / Narrow	6,5x7x40	57
850 mm	Sık / Narrow	6x7x40	58
850 mm	Sık / Narrow	6,5x7x40	58
900 mm	Sık / Narrow	6,5x7x40	64



Granit Ebatlama Testereleri / Granite Sizing Blades

GRANİT EBATLAMA TESTERELERİ / GRANITE SIZING BLADES

Testere Çapı Diameter of The Saw	Testere Tipi Type of Saw	Soket Boyutları Gen. x Yüks. x Uz. Size of Segment W x H x L	Soket Sayısı Number of Segment
300 mm	Normal / Standard Sessiz / Silent	3,2x10x40 3,2x15x40	21
300 mm	Normal / Standard Sessiz / Silent	3,2x20x40 3,2x25x40	20
350 mm	Normal / Standard Sessiz / Silent	3,2x10x40 3,2x15x40	25
350 mm	Normal / Standard Sessiz / Silent	3,2x20x40 3,2x25x40	23
400 mm	Normal / Standard Sessiz / Silent	3,6x10x40 3,6x15x40	28
400 mm	Normal / Standard Sessiz / Silent	3,6x20x40 3,6x25x40	27
450 mm	Normal / Standard Sessiz / Silent	3,8x10x40 3,8x15x40	32
450 mm	Normal / Standard Sessiz / Silent	3,8x20x40 3,8x25x40	30
500 mm	Seyrek / Wide	4,5x10x40	30
500 mm	Sık / Narrow	4,5x10x40	36
550 mm	Seyrek / Wide	4,5x10x40	36
550 mm	Sık / Narrow	4,5x10x40	42
600 mm	Seyrek / Wide	4,5x10x40	36
600 mm	Sık / Narrow	4,5x10x40	42
700 mm	Seyrek / Wide	5,5x10x40	40
700 mm	Sık / Narrow	7.1-6,0x12,5x24	50
800 mm	Seyrek / Wide	5,5x10x40	46
800 mm	Sık / Narrow	7.6-6,5x12,5x24	57



Mermer Ebatlama Testere / Marble Sizing Blades

HRK 200 mm'den - 800 mm'ye kadar Mermer Testere üretilmektedir. Sessiz, Lazer ve Standart seçenekleriyle size alternatif ürünler sunmaktadır.

HRK manufactures Marble Saws from 200 mm to 800 mm, offering you alternative products with Silent, Laser and Standard options.

MERMER EBATLAMA TESTERELERİ / MARBLE SIZING BLADES

Testere Çapı Diameter of The Saw	Testere Tipi Type of Saw	Soket Boyutları Gen. x Yüks. x Uz. Size of Segment W x H x L	Soket Sayısı Number of Segment
200 mm	Normal / Standard	2,4x8x40	13
200 mm Fuga	Normal / Standard	6x8x40	13
250 mm	Normal / Standard	2,4x8x40	17
250 mm Fuga	Normal / Standard	6x8x40	17
300 mm	Normal / Standard Sessiz / Silent	2,4x8x40	21
300 mm	Lazer / Laser	2,4x8x40	23
350 mm	Normal / Standard Sessiz / Silent	3,2x8x40	25
350 mm	Lazer / Laser	3,2x8x40	27
400 mm	Normal / Standard Sessiz / Silent	3,6x8x40	28
400 mm	Lazer / Laser	3,6x8x40	31
450 mm	Normal / Standard Sessiz / Silent	3,8x8x40	32
500 mm	Normal / Standard	4,5x7x40	36
600 mm	Normal / Standard Sessiz / Silent	4,5x7x40	42
625 mm	Normal / Standard Sessiz / Silent	5x7x40	42
700 mm	Normal / Standard	5,5x7x40	50
800 mm	Normal / Standard	6x7x40	57

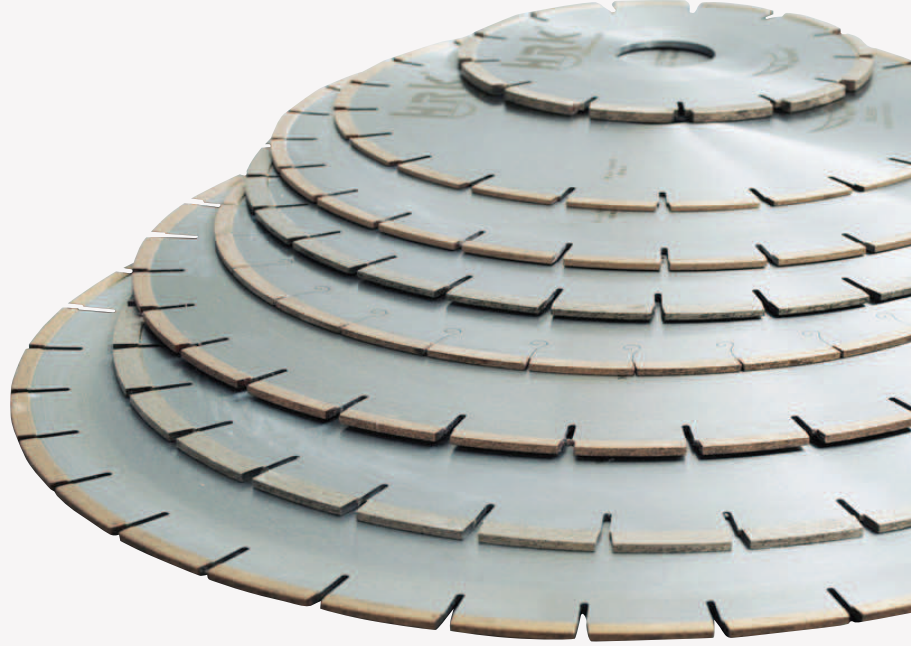

MERMER EBATLAMA TESTERELERİ DEVİR TABLOSU / MARBLE SIZING BLADES ROTATION TABLE

Çap Diameter	Flanş Çapı Diameter of Flange	Çevresel Hız m/ Saniye / Peripheral Speed m/Second				
		50	55	60	65	70
300	120	3185	3503	3822	4140	4459
350	160	2730	3003	3276	3549	3822
400	160	2389	2627	2866	3105	3344
450	160	2123	2335	2548	2760	2972
500	170	1911	2102	2293	2484	2675
550	170	1737	1911	2085	2258	2432
600	170	1592	1752	1911	2070	2229
650	170	1470	1617	1764	1911	2058
700	200	1365	1501	1638	1774	1911
750	200	1274	1401	1529	1656	1783
800	200	1194	1314	1433	1553	1672
850	200	1124	1236	1349	1461	1574

Seramik-Cam-Porselen Ebatlama Testereleri

Ceramic-Glass-Porcelain Sizing Blades

SERAMİK-CAM-PORSELEN-YAPAY TAŞ EBATLAMA TESTERELERİ

CERAMIC-GLASS-PORCELAIN-ARTIFICIAL STONE SIZING BLADES

Testere Çapı Diameter of The Saw	Testere Tipi Type of Saw	Soket Boyutları Gen. x Yüks. x Uz. Size of Segment W x H x L	Soket Sayısı Number of Segment
200 mm	Lazer / Laser	1,2 x 10 x 40	15
200 mm	Lazer / Laser	1,8 x 10 x 40	15
250 mm	Lazer / Laser	1,2 x 10 x 40	18
250 mm	Lazer / Laser	1,8 x 10 x 40	18
250 mm	Lazer / Laser	2,0 x 10 x 40	18
250 mm	Lazer / Laser	2,2 x 10 x 40	18
300 mm	Lazer / Laser	1,2 x 10 x 40	23
300 mm	Lazer / Laser	1,8 x 10 x 40	23
300 mm	Lazer / Laser	2,0 x 10 x 40	23
300 mm	Lazer / Laser	2,2 x 10 x 40	23
KARIŞIK KESİM / SHARP EDGE MIXED			
350 mm	Sessiz / Silent	3,2 x 10 x 40	25
400 mm	Sessiz / Silent	3,6 x 10 x 40	28
SERAMİK - PORSELEN / CERAMIC - PORCELAIN			
350 mm	Lazer / Laser	3,2 x 10 x 40	27
400 mm	Lazer / Laser	3,6 x 10 x 40	31
350 mm	Lazer Sessiz Laser Silent	3,2 x 10 x 40	27
400 mm	Lazer Sessiz Laser Silent	3,6 x 10 x 40	31
45 DERECE AÇILI KESİM / MITER CUTTING			
350 mm	Lazer Sessiz Kademeli Laser Silent	3,2 x 10 x 40	27

Farklı özelliklerde seramik, porselen ve yapay taşlar için hassas kesim testereleri üretilmektedir. Mevcut standart testerelerin uygun olmaması durumunda, Ar-Ge departmanımız tarafından ürüne özel kesici testereler geliştirilmektedir.

Precise cutting saws are manufactured for ceramics, porcelain and artificial stones with various properties. In case the existing standard saws are not suitable, product-specific cutting saws are developed by our R&D department.



Turbo Testereler / Turbo Blades

Ürün Kodu Product Number	Ürün Ölçüsü Product Size	Malzeme Açıklaması Description of Goods	Teknik Detay Technical Detail
HMT-01	Q180 mm	Turbo Testere Tiger Diş Turbo Blade Tiger Teeth	Göbek Çapı: 22.2, Güçlendirilmiş Gövde, Sulu & Kuru Core Size: 22.2, Reinforced Body, Wet & Dry
HMT-02	Q180 mm	Turbo Testere Sonsuz Diş Turbo Blade Continuous Teeth	Göbek Çapı: 22.2, Güçlendirilmiş Gövde, Sulu & Kuru Core Size: 22.2, Reinforced Body, Wet & Dry
HMT-03	Q150 mm	Turbo Testere Sonsuz Diş Turbo Blade Continuous Teeth	Göbek Çapı: 22.2 (Bilezikli Çap 15.9), Düz Gövde, Sulu & Kuru Core Size: 22.2 (With Ring 15.9), Flat Body, Wet & Dry
HMT-04	Q125 mm	Turbo Testere Sonsuz Diş Turbo Blade Continuous Teeth	Göbek Çapı: 22.2 (Bilezikli Çap 15.9), Düz Gövde, Sulu & Kuru Core Size: 22.2 (With Ring 15.9), Flat Body, Wet & Dry
HMT-05	Q100 mm	Turbo Çift Kat Çanak Turbo Double Cup Wheel	Bağlantı Şekli: M14, Sulu & Kuru Connection Type: M14, Wet & Dry
HMT-06	Q180 mm	Elektroliz Kaplamalı Testere Electroplated Blade	Göbek Çapı: 22.2, Düz Gövde, Sulu & Kuru Core Size: 22.2, Flat Body, Wet & Dry
HMT-07	Q180 mm	Elektroliz Kaplamalı Testere Electroplated Blade	Bağlantı Şekli: M14, Flaşlı, Sulu & Kuru Connection Type: M14, With Flange, Wet & Dry
HMT-08	Q125 mm	Elektroliz Kaplamalı Testere Electroplated Blade	Bağlantı Şekli: M14, Flaşlı, Sulu & Kuru Connection Type: M14, With Flange, Wet & Dry



HMT-01



HMT-02



HMT-03



HMT-04



HMT-05



HMT-06



HMT-07



HMT-08

Beton Testereleri / Concrete Blades

BETON VE ASFALT TESTERELERİ / CONCRETE and ASPHALT SAWS

Ø Çap Diameter	Ürün Cinsi Product	Soket Ölçüsü Size of Segment	Soket Sayısı Number of Segment
300 mm	Beton ve Asfalt Testereleri Concrete and Asphalt Saw	3,2 x 10 x 40 mm	18
350 mm		3,2 x 10 x 40 mm	21
400 mm		3,6 x 10 x 40 mm	24
450 mm		3,8 x 10 x 40 mm	26



Derz Testereleri / Concrete Blades

DERZ TESTERELERİ / IN GROOVING SAWS

Ø Çap Diameter	Ürün Cinsi Product	Orta Soket Ölçüsü Size of Middle Segment	Yan Soket Ölçüsü Size of Side Segment	Soket Sayısı Number of Segment
350 mm	Derz Testereleri In grooving Saw	3,2 x 10 x 40 mm	5,0 x 10 x 40-45° mm	18 - 21 - 18
350 mm		3,8 x 10 x 40 mm	5,0 x 10 x 40-45° mm	18 - 21 - 18
350 mm		6,5 x 10 x 40 mm	5,0 x 10 x 40-45° mm	18 - 21 - 18

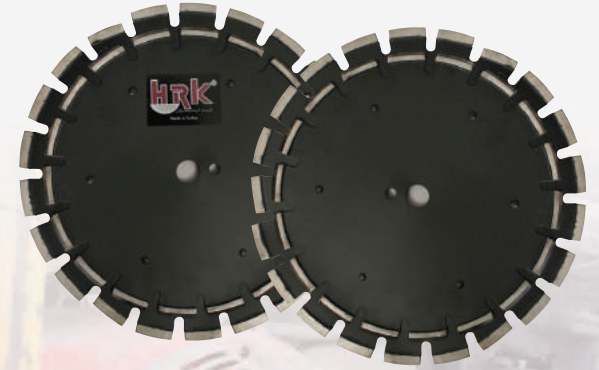

Beton Testereleri / Concrete Blades

BETON VE ASFALT TESTERELERİ / CONCRETE and ASPHALT SAWS

Ø Çap Diameter	Ürün Cinsi Product	Soket Ölçüsü Size of Segment	Soket Sayısı Number of Segment
800 mm	Beton Testeresi Concrete Saw	4,5 x 10 x 40 mm	46
800 mm		5,0 x 10 x 40 mm	46
800 mm		5,5 x 10 x 40 mm	46
1000 mm		4,5 x 10 x 40 mm	56
1000 mm		5,0 x 10 x 40 mm	56
1200 mm		4,5 x 10 x 40 mm	64

İnşaat sektörü Hartek'in oldukça etkin olduğu alanların başında gelmektedir. Hartek-HRK Beton Testereleri, ürünün üstün performansı sayesinde sektörde yaygın olarak kullanılmaktadır. Beton testereleri farklı ebatlarda, standart ve lazer kaynak seçenekleriyle üretilmektedir.

Building sector is one of the leading fields where Hartek company is highly effective. Hartek-HRK Concrete Blades are commonly used in the sector thanks to high performance of the product group. Concrete Blades are manufactured in various sizes with standard and laser welding options.



Kalibre Tepsileri / Calibrating Plates

Kalibre Çemberleri

Kalibre çemberleri, makine özelliklerine göre çeşitli tasarım ve çaplarda üretilmektedir. Elmas soketler gümüş lehimleme yöntemiyle kalibre gövdelerine kaynatılmakta ve otomatik makineler ile balans kontrolü yapılmaktadır.

Kalibre Soket Ölçüsü: 8x10x24 mm

Calibrator Ring / Disc

Calibrator rings are manufactured in various designs and diameters with reference to the machine specifications the ring to be used.

Diamond segments are welded to the rings by silver brazing method. Balance adjustment of the ring are made by fully automatic machines.

Our standard calibration segment size: 8x10x24 mm



Parça Kalibreler

Kalibratör Parçaları, kalibratör tepsilerine vidalanarak kullanılır.

Kalibre tepsilerinin üzerine monte edilen parça kalibreler ile uyumu çok önemlidir.

Özel tasarımlarda kalibre parçaları da, teknik çizimi gönderilmesi durumunda üretilmektedir.

Standart Soket Ölçüsü: 8x10x24 mm

Calibrator Parts

Calibrator Parts are used by screwing the calibrator plate.

It is also possible to manufacture specially designed calibrator parts by technical drawing of the parts.

Standard Segment Size: 8x8x24 mm



Vidalı Kalibreler

Vidalı Tip Kalibreler müşteri uygulama taleplerine göre özel olarak tasarlanmıştır. Elmas soketler plaka üzerine vida ile monte edilir ve bu özellik kullanıcıya soket değiştirme kolaylığı sağlar.

Soket boyutu: Q20xh20

Bağlantı vidası boyutu: M14 * 60 (farklı boyut vida kullanımı mümkündür)

Calibrator With Screw

Screw Type Calibration Plates are specially designed with reference to customer application requirements. Diamond segments are mounted on the plate by screw and this feature provides a convenience to the user to replace the diamond segments.

Segment size : Q20xh20

Connection screw size: M14*60 (any other size possible)



Kalibre Tamburları / Calibrating Rollers

Ürün Tipi Product Type	Ø Çap Diameter	Soket Ölçüsü Size of Segment	Soket Adeti Piece of Segment
CR-01	215 mm	5 x 12,5 x 40	154
CR-02	190 mm	5 x 10 x 20	100
CR-03	215 mm	30 x 9,5 x 54	20
CR-04	180 mm	4,5 x 9,5 x 24	84
CR-04	180 mm	10 x 9,5 x 24	36
CR-05	225 mm	9 x 12 x 40 - 42,5	22
CR-06	225 mm	3,2 x 12,5 x 24	26
CR-07	200 mm - 300 mm	9 x 12 x 40 - 2,54	

HRK Kalibrasyon Silindirleri, doğal taşların, işlenmiş taşların ve yapay taşların kalibre edilmesi ve kalınlık tespiti için tasarlanmıştır.

HRK silindirleri her türlü kalibrasyon, parlatma makinelerine uygun üretilebilir. Farklı gereksinimlere göre özel tasarımlar yapılmaktadır.

HRK Calibrating Rollers are designed for calibrating and thickness fixing of natural stones, engineered stones and artificial stones.

HRK rollers can be mounted on all calibrating, grinding and polishing machines. Special designs are available with reference to different specific requirements.



CR - 01



CR - 02



CR - 03



CR - 04



CR - 05



CR - 06



CR - 07

Elmas Pençe (Frankfurt) - Elmas Fickert Abrasiv Automatic Abrasive (Frankfurt) - Diamond Fickert Abrasive

HRK Frankfurt Tipi Aşındırıcı, en kolayından en zoruna kadar her türlü taş ve beton döşeme, zemin ve fayans için kullanılabilir. İdeal parlaklık, yüksek performans ve uzun ömür dayanımı sağlar.

HRK Frankfurt Type Abrasive are applicable for all kinds of stone and concrete slabs, floor and tiles from the easiest to the most difficult ones, bringing you an ideal shine and high-definition result. Our diamond abrasives are approved for their excellent shaping effect, good sharpness, high gloss and long working lifetime.

TİP 1 / 8 x 10 x 24 mm / 13 SOKET

Elmas soketler, gövdeye gümüş lehimleme yöntemiyle monte edilmektedir. Yandaki görselde , 13 soketli standart ürünümüz bulunmaktadır. Bunun yanı sıra farklı soket sayısında ve çeşitli tasarımlara sahip pençe tipi elmas abrasivlerin üretimi mümkündür.

TYPE 1 / 8 x 10 x 24 mm / 13 SEGMENT

Diamond segments are welded on the body of this type of abrasive. Photo represents our standard product with 13 segments but it is possible to make abrasives with different number of diamond segments and various designs.



TİP 2/14 x 12 x 30 mm / 6 SOKET

Sinterlenmiş elmas soketler alüminyum gövdeye M16 Vidalar ile bağlanır. Standart modelimizin fotoğraftaki şekilde 6 soketlidir. Farklı soketler ve özel gövde tasarımları ile size özel ürünler de yapılmaktadır.

TYPE 2 / 14 x 12 x 30 mm / 6 SEGMENT

Sinterized diamond segments are connected to the aluminium body by M16 Screws. Photo represents our standard model is with 6 segments. Special body designs and abrasives with different number of segments are manufactured.



TİP 3 / (20-34) x 19 x 100 mm / 2 SOKET

Sinterlenmiş özel büyük elmas soketler alüminyum gövdeye vidalarla monte edilir.

TYPE 3 / (20-34) x 19 x 100 mm / 2 SEGMENT

Sinterized special large diamond segments are mounted by screws on to the aluminium body.

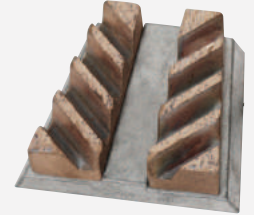

TİP 4 / (Q 20x15) / 8 SOKET

Sinterlenmiş özel yuvarlak elmas soketler demir gövdeye kaynatılarak sabitlenir.

TYPE 4 / (Q 20x15) / 8 SEGMENT

Sinterized Circular Special Segments are welded on the steel body.



ELMAS ABRASİV (FICKERT)

Elmas Abrasiv (Fickert) HRK Fickert Tipi Abrasiv, her türlü granit, doğaltaş döşeme ve karolara uygulanabilir.

Farklı taş tiplerine göre 36-46-60-80-120-220-320 elmas kalınlıklarında abrasivler üretilebilmektedir.

AUTOMATIC DIAMOND ABRASIVE (FICKERT TYPE)

HRK Fickert Type Abrasive are applicable for all kinds of granite and enginered stone slabs and tiles. These tools can be used on all calibrating grinding and polishing machines.

36-46-60-80-120-220-320 Diamond Grids are used with reference to the different stone types.



Manuel Silim Kalibratörler / Manual Polishing Calibrations

Ürün Tipi Product Type	Ürün Tanımı Product Size	Soket Ölçüsü Size of Segment	Soket Adeti Piece of Segment
MA-01	Q 300 mm	8 x 8 x 24 mm	30
MA-02	Q 100 mm	8 x 8 x 24 mm	9
MA-03	50 mm *100 mm	8 x 8 x 24 mm	9
MA-04	50 mm *50 mm	8 x 8 x 40 mm	2
MA-05	50 mm *70 mm	8 x 8 x 40 mm	2

Manuel Elmas Abrasivler, uygun manuel makinelere monte edilerek çeşitli uygulamalarda kullanılmaktadır.

En yaygın uygulamalar: Beton yüzey parlatma öncesi yüzey kalibrasyonu, Zemin epoksi kaplama öncesi, deforme olmuş beton yüzeylerin düzeltilmesi ve seviye farklılıklarının giderilmesi, Zemin döşeme sonrası kalıntıların temizlenerek zeminin cilaya hazırlanması, Ham asfalt döşemelerinde seviye farklılıklarının giderilmesi.

Manuel Abrasives are used in various applications mounted on manual machines.

Most common applications: Concrete surface calibration before surface polishing, preliminary work before floor epoxy covering, straightening the deformed concrete surfaces and removing the level differences, cleaning the ruins after floor tiling before floor polishing, removing the level differences of rawly paved stones.

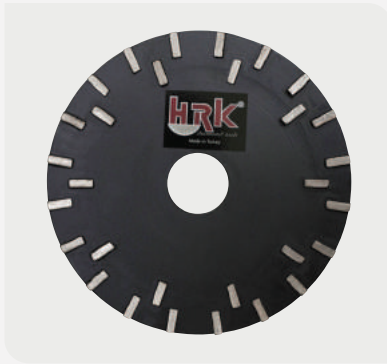

MA - 01



MA - 02



MA - 03

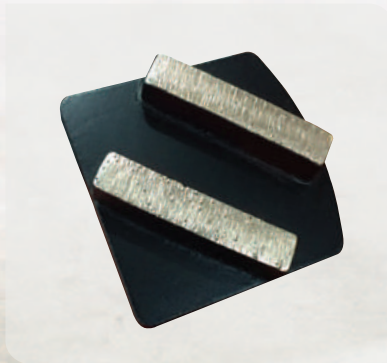

MA - 02



MA - 03

Soketli Profiller / Segmented Profiles



TAM KAVIS PROFİLLER / FULL BULLNOSE PROFILES

Ø Çap Diameter	Ürün Cinsi / Product	a	r
320 mm	2 cm Tam Kavis Profil / Bullnose Profile	2 cm	1 cm
320 mm	3 cm Tam Kavis Profil / Bullnose Profile	3 cm	1,5 cm
320 mm	4 cm Tam Kavis Profil / Bullnose Profile	4 cm	2 cm
320 mm	5 cm Tam Kavis Profil / Bullnose Profile	5 cm	2,5 cm
320 mm	6 cm Tam Kavis Profil / Bullnose Profile	6 cm	3 cm

YARIM KAVIS PROFİLLER / HALF BULLNOSE PROFILES

Ø Çap Diameter	Ürün Cinsi / Product	a	b
320 mm	1 cm Yarım Kavis Profil / Half Bullnose Profile	1 cm	1 cm
320 mm	1,5 cm Yarım Kavis Profil / Half Bullnose Profile	1,5 cm	1,5 cm
320 mm	2 cm Yarım Kavis Profil / Half Bullnose Profile	2 cm	2 cm
320 mm	2,5 cm Yarım Kavis Profil / Half Bullnose Profile	2,5 cm	2,5 cm
320 mm	3 cm Yarım Kavis Profil / Half Bullnose Profile	3 cm	3 cm



Elektroliz-Vakum Profiller / Electroplated-Vacuum Brazed Profiles

Elektroliz kaplamalı ve Vakum Brazed profiller siparişiniz doğrultusunda istenilen şekil ve boyutta üretilebilmektedir.

Electroplated and Vacuum Brazed Profiles are manufactured in any shape and dimension by mutually confirmed technical drawing. Segmented profiles are manufactured as full and half bullnose as various diameters and dimensions.

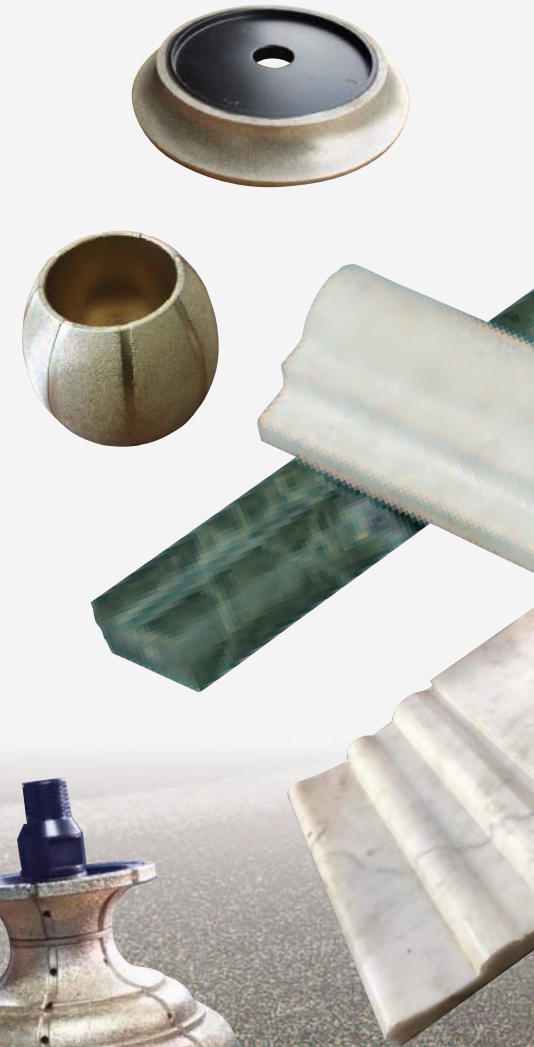
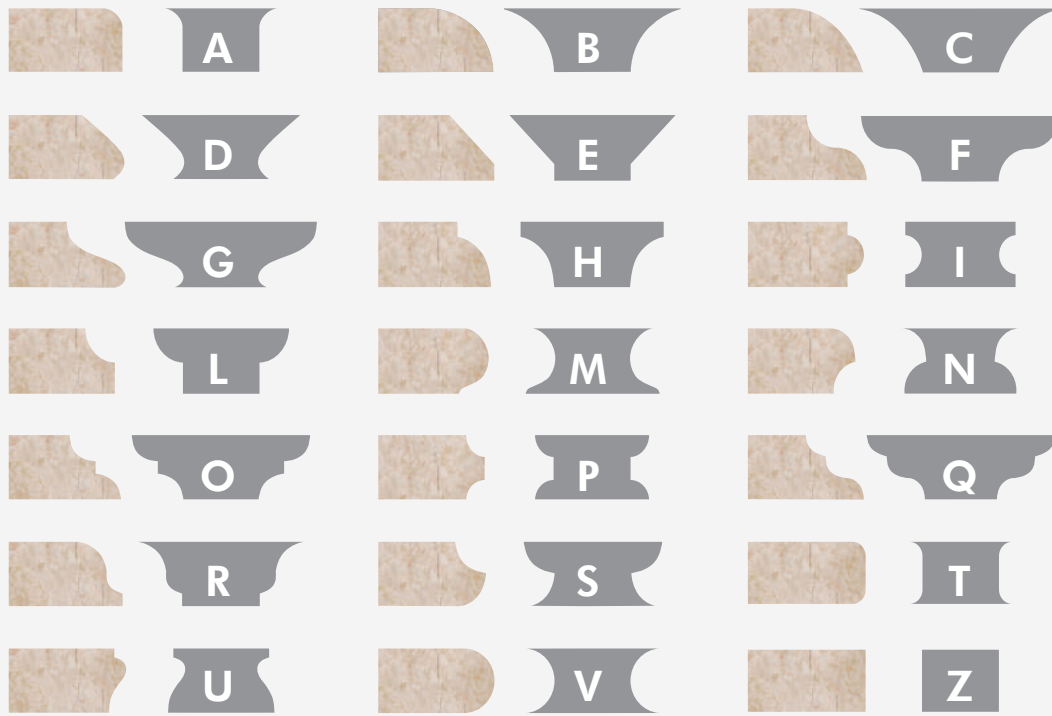

Soketli Taramalar / Segmented Canal Saws (Milling Wheels)

Ø Çap Diameter	Ürün Cinsi Kind of Product	Kanal Geniřlięi Size of Canal	Soket Ölçüsü Size of Segment	Soket Adeti Piece of Segment
355mm (14")	Tarama Testeresi (Teflon Gövde) / Milling Wheel (Teflon Core)	25,40 mm (1")	8 x 8 x 25,40 (diagonal)	48 Adet
355mm (14")	Tarama Testeresi (Teflon Gövde) / Milling Wheel (Teflon Core)	31,75 mm (1 1/4")	8 x 8 x 31,75 (diagonal)	48 Adet
355mm (14")	Tarama Testeresi (Teflon Gövde) / Milling Wheel (Teflon Core)	38,10 mm (1 1/2")	8 x 8 x 38,10 (diagonal)	48 Adet
355mm (14")	Tarama Testeresi (Teflon Gövde) / Milling Wheel (Teflon Core)	50,80 mm (2")	8 x 8 x 50,80 (diagonal)	48 Adet
320 mm	Tarama Testeresi (Metal Gövde) / Milling Wheel (Metal Core)	8 mm	8 x 8 x 24 mm	39 Adet
320 mm	Tarama Testeresi (Metal Gövde) / Milling Wheel (Metal Core)	10 mm	8 x 10 x 24 mm	39 Adet
320 mm	Tarama Testeresi (Metal Gövde) / Milling Wheel (Metal Core)	15 mm	8 x 8 x 15 mm	59 Adet
320 mm	Tarama Testeresi (Metal Gövde) / Milling Wheel (Metal Core)	20 mm	7 x 8 x 20 mm	62 Adet
320 mm	Tarama Testeresi (Metal Gövde) / Milling Wheel (Metal Core)	25 mm	8 x 8 x 24 mm	59 Adet
320 mm	Tarama Testeresi (Metal Gövde) / Milling Wheel (Metal Core)	30 mm	8 x 8 x 30 mm	59 Adet
320 mm	Tarama Testeresi (Metal Gövde) / Miter Wheel (Metal Core)	8 mm / 45°	8 x 8 x 24 mm	39 Adet
320 mm	Tarama Testeresi (Metal Gövde) / Miter Wheel (Metal Core)	10 mm / 45°	8 x 10 x 24 mm	39 Adet
320 mm	Tarama Testeresi (Metal Gövde) / Miter Wheel (Metal Core)	15 mm / 45°	8 x 8 x 15 mm	59 Adet

HRK Tarama Testeresleri metal gövde ve teflon gövde olmak üzere farklı gövde çeşidi ile üretilebilmektedir. Teflon gövde daha hafif olduğu için özellikle büyük çaplarda kullanım rahatlığı sağlamaktadır. Mermer, traverten, granit, bazalt vb doğaltaşlar ve beton malzemenin işlenmesi için kullanılmaktadır.

Kanal açma ve tarama testeresleri köprü kesme makinelerinin yanı sıra pek çok makine çeşidinde kullanılmaktadır. İşlenecek malzemenin özelliğine uygun olarak, soketli, elektroliz veya vakum kaplamalı alternatif ürünler sunulmaktadır. Standart üretim ölçülerimiz tabloda belirtilmiştir. Müşteri gereksinimlerine göre diğer çaplar, tasarımlar ve boyutlarda da üretim imkanları mevcuttur.

HARTEK Milling Wheels-Canal Saws are manufactured in two types of cores. Metal body and much lighter Teflon body are available selections. In addition to the core selections, diamond part of the tools brings the options of segmented, electroplated and vacuum brazing technology.

Hartek milling wheels are used in many types of machines as well as bridge cutting machines for marble, granite, natural stones and leveling concrete tables.

Our standard production sizes are mentioned in the table. Other diameters, designs and sizes are also available with reference to customer requirements.



Elektroliz-Vakum Taramalar Electroplated-Vacuum Brazed Canal Saws (Milling Wheels)

Elektroliz ve son teknoloji Vakum Brazed Taramalar, doğal taş fabrika ve atölyelerinin üretim süreçlerinde ciddi destek ve çözüm sunan, esnek çap-ebatlarda üretilebilen ve birçok farklı uygulamada kullanılabilen bir ürün grubu olarak hizmetinize sunulmaktadır.

Electroplated and latest technology Vacuum Brazed Milling Wheels are great assistants to fabricators available to be used in various applications and can be manufactured in flexible diameters and sizes.



Beton Karotları / Concrete Drilling Tools

Ø Çap Diameter	Uzunluk Length	Bağlantı Şekli Connection Type	Gövde Kalınlığı Thickness	Soket Ölçüsü Size of Segment	Soket Adeti Piece of Segment
12 mm	450 mm	1 1/4"	2 mm	3,5x8x12	2
20 mm	450 mm	1 1/4"	2 mm	3,5x8x20	2
25 mm	450 mm	1 1/4"	2 mm	3,5x8x20	3
33 mm	450 mm	1 1/4"	2 mm	3,5x8x26	3
42 mm	450 mm	1 1/4"	2 mm	3,5x8x25	4
52 mm	450 mm	1 1/4"	2 mm	3,5x8x28	5
62 mm	450 mm	1 1/4"	2 mm	3,5x8x28	5
72 mm	450 mm	1 1/4"	2 mm	3,5x8x28	6
82 mm	450 mm	1 1/4"	2 mm	3,5x8x27	7
92 mm	450 mm	1 1/4"	2 mm	3,5x8x27	8
102 mm	450 mm	1 1/4"	2 mm	3,5x8x27	9
112 mm	450 mm	1 1/4"	2 mm	3,5x8x27	9
122 mm	450 mm	1 1/4"	2 mm	3,5x8x26	10
132 mm	450 mm	1 1/4"	2 mm	3,5x8x26	12
152 mm	450 mm	1 1/4"	2 mm	3,5x8x26	13
162 mm	450 mm	1 1/4"	2,5 mm	3,5x8x26	13
182 mm	450 mm	1 1/4"	2,5 mm	4,5x8x26	14
202 mm	450 mm	1 1/4"	2,5 mm	4,5x8x26	16
225 mm	450 mm	1 1/4"	3 mm	4,5x8x26	17
250 mm	450 mm	1 1/4"	3 mm	4,5x8x26	17
300 mm	450 mm	1 1/4"	3 mm	4,5x8x26	18
320 mm	450 mm	1 1/4"	3 mm	4,5x8x26	18
350 mm	450 mm	1 1/4"	3 mm	4,5x8x26	20
400 mm	450 mm	1 1/4"	3 mm	4,5x8x26	22



Karatlar / Drilling Tools

KAROTLAR / DRILLINGS TOOLS

Ø Çapı Diameter	Uzunluk Length	Gövde Kalınlığı Thickness	Soket Ölçüsü Sizes of Segment	Soket Adeti Piece of Segment
12 mm	60 mm	2 mm	3,5x8x12	2
20 mm	60 mm	2 mm	3,5x8x20	2
25 mm	60 mm	2 mm	3,5x8x20	3
33 mm	60 mm	2 mm	3,5x8x26	3
42 mm	60 mm	2 mm	3,5x8x25	4
52 mm	60 mm	2 mm	3,5x8x28	5
62 mm	60 mm	2 mm	3,5x8x28	5
72 mm	60 mm	2 mm	3,5x8x28	6
82 mm	60 mm	2 mm	3,5x8x27	7
92 mm	60 mm	2 mm	3,5x8x27	8
102 mm	60 mm	2 mm	3,5x8x27	9

Her türlü doğal taş deliminde kullanılan HRK Karotları, standart ebatlar dışında tüketici ihtiyacına uygun olarak istenilen çapta ve boyda üretilmektedir.

HRK Drilling Tools are used for drilling all kinds of Natural Stones which are available to be produced with reference to required length and diameter.



82

62



52

42

33



20

20-M14

12



Elektroliz-Vakum Karotları

Electroplated-Vacuum Brazed Drilling Tools

Ø Çap Diameter	Uzunluk Length	Gövde Kalınlığı Thickness	Kullanım Alanı Usage Area
12 mm	60 mm	2 mm	Mermer - Granit - Kuvarsit - Seramik Marble - Granite - Quartzite - Ceramic
20 mm	60 mm	2 mm	Mermer - Granit - Kuvarsit - Seramik Marble - Granite - Quartzite - Ceramic
25 mm	60 mm	2 mm	Mermer - Granit - Kuvarsit - Seramik Marble - Granite - Quartzite - Ceramic
33 mm	60 mm	2 mm	Mermer - Granit - Kuvarsit - Seramik Marble - Granite - Quartzite - Ceramic
42 mm	60 mm	2 mm	Mermer - Granit - Kuvarsit - Seramik Marble - Granite - Quartzite - Ceramic
52 mm	60 mm	2 mm	Mermer - Granit - Kuvarsit - Seramik Marble - Granite - Quartzite - Ceramic
62 mm	60 mm	2 mm	Mermer - Granit - Kuvarsit - Seramik Marble - Granite - Quartzite - Ceramic
82 mm	60 mm	2 mm	Mermer - Granit - Kuvarsit - Seramik Marble - Granite - Quartzite - Ceramic
102 mm	60 mm	2 mm	Mermer - Granit - Kuvarsit - Seramik Marble - Granite - Quartzite - Ceramic



CNC Gravür Frezeleri / CNC Router Bits For Engraving

HRK CNC Uçları, çeşitli tasarım ve boyutlarda Vakum Lehimleme Teknolojisi ile üretilmektedir.

Müşteri ihtiyaçlarına ve siparişlerine göre farklı şekil ve boyutlarda da üretim imkanları mevcuttur.

HRK CNC Uçlar ile Doğal Taşlara ve Yapay malzemelere işleme yapılabilmektedir.

HARTEK CNC Bits for Engraving are manufactured by Vacuum Brazing Technology in various designs and sizes.

With reference to customer requirements and orders, other shapes and sizes are also available.

HARTEK CNC Bits are highly capable of processing a good deal of Natural Stone, Artificial and Engineered Stone types.



CNC Parmak Frezeleri / CNC Finger Bits

Ø Çap Diameter	Uzunluk Length	Bağlantı Şekli Connection Type	Model Thickness	Soket Ölçüsü Size of Segment	Soket Adeti Piece of Segment
16 mm	40 mm	1/2 Gas	Kavisli - Düz / Curved - Straight	5 x 3,5 x 40	4
20 mm	40 mm	1/2 Gas	Kavisli - Düz / Curved - Straight	5 x 3,5 x 40	5
22 mm	40 mm	1/2 Gas	Kavisli - Düz / Curved - Straight	5 x 3,5 x 40	6



Her geçen gün
daha çok yatırım;
daha çok müşteri
memnuniyeti

Mermer, Granit ve Doğal taşların kesiminde kullanılan Dairesel Testereler, Katrak Lamaları ve Elmaslı Kesme Telleri ile yüksek üretim performansı ve minimum üretim maliyetleri elde edilebilmektedir.

HRK, üretim sürecine son teknoloji makinelerini, eğitimli personelini ve sürekli kalite kontrolü de dahil ederek müşteri memnuniyetini maksimum seviyede tutmayı amaç edinmiştir.

More investments,
more customer
satisfaction every
passing day

High production performance and minimum production costs can be achieved with Circular Saws, Gang Saw Blades and Diamond Cutting Wires used for cutting marble, granite and natural stones.

HRK aims to keep customer satisfaction in the maximum by adding high technology machines, trained staff and continuous quality control to the production process.

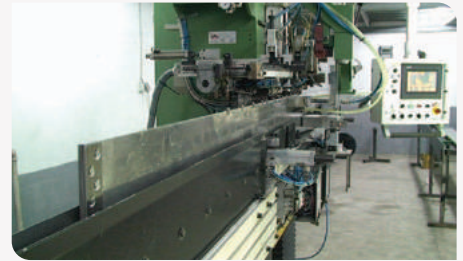
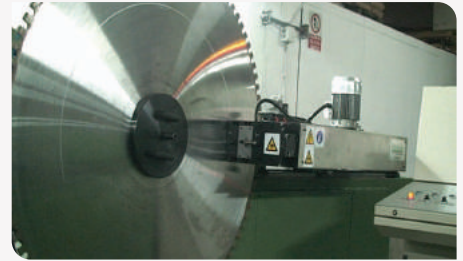
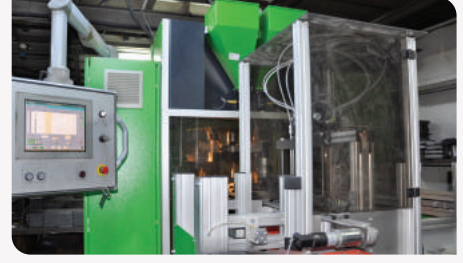
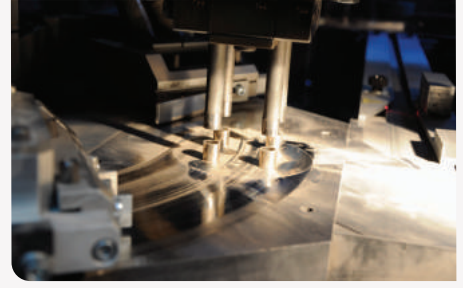



Mermer Granit İnşaat Makine ve
Ekipmanları San. Tic. Ltd. Şti.

Merkez Fabrika / Head Factory

Karayolları Mah. Cebeci Cad. 648 Sk. No: 16 G.O.Paşa - İstanbul / TURKEY
Tel: +90 (212) 538 47 48 +90 (212) 535 00 17 Fax: +90 (212) 535 00 08

Bilecik Fabrika / Bilecik Factory

1. Organize Sanayi Bölgesi Ata Bulvarı No: 4 Bilecik / TURKEY
Tel: +90 (228) 216 01 84 Fax: +90 (228) 216 01 87

Afyon Fabrika / Afyon Factory

Organize Sanayi Bölgesi 1.Cadde 7.Sokak No:2 Afyonkarahisar / TURKEY
Tel: +90 (272) 223 19 44 Fax: +90 (272) 223 19 45

Burdur Şube / Burdur Branch

Şirinevler Mah. Armağan İlci Bulvarı No: 38 Burdur / TURKEY
Tel: +90 (248) 235 20 36 Fax: +90 (248) 235 20 37

www.hartek.com.tr • info@hartek.com.tr

444 8 475